

Article number: 207321M121416ST

Description: E+G Shoulder screw
GN 732.1-M12-14-16-ST

Measures

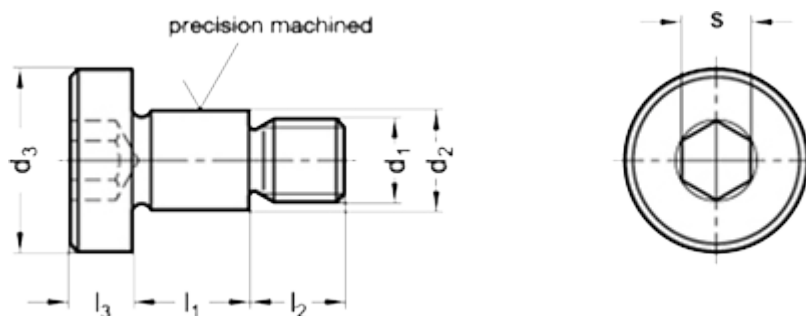

Application example

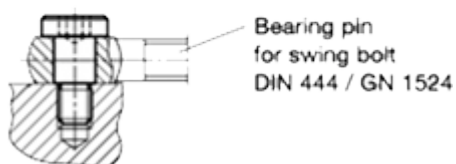

d_1	= M 12
d_2	= 14 -0.05/-0.08
d_3	= 22
$l_1 + 0.20/+0.13$	= 16
l_2	= 16
l_3	= 8
s	= 8
Weight in (g)	= 33